

PP Anbohrschelle Innengewinde Messing PN16

PB0300

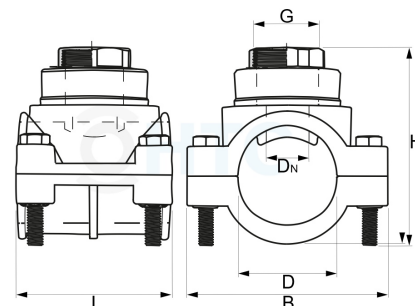

Alle Maßangaben in Millimeter, Gewichtsangaben in Gramm. Für die fotografische Darstellung verwenden wir eine Artikelgröße sowie Studioliicht. Die Abbildungen, technischen Daten, Maße und Ausführungen sind unverbindlich. Sie gelten nicht als zugesicherte Eigenschaften oder als Beschaffenheits- oder Haltbarkeitsgarantien. Wir behalten uns jederzeit Änderung ohne Ankündigung vor. Die Nutzmaße sind definiert bzw. verstärkt dargestellt bzw. ergeben sich aus der Artikelbezeichnung. Weitere Maße dienen ausschließlich der Darstellungsunterstützung. Bei Zweckentfremdung bitten wir dies zu beachten.

Artikel-Nr.	Variante	B	D	DN	G	H	L	Schraube	Preis
PB0300.025.020	25mm x 1/2"	81	25	15	1/2" (20,96mm)	58 (74)	54	4x M8	3,02 €*
PB0300.025.025	25mm x 3/4"	81	25	20	3/4" (26,44mm)	60 (73)	54	4x M8	3,53 €*
PB0300.032.020	32mm x 1/2"	80	32	15	1/2" (20,96mm)	71 (82)	64	4x M8	3,36 €*
PB0300.032.025	32mm x 3/4"	80	32	20	3/4" (26,44mm)	72 (82)	63	4x M8	3,86 €*
PB0300.032.032	32mm x 1"	80	32	21,5	1" (33,25mm)	76 (87)	64	4x M8	6,68 €*
PB0300.040.020	40mm x 1/2"	87	40	15	1/2" (20,96mm)	81 (88)	74	4x M8	3,95 €*
PB0300.040.025	40mm x 3/4"	87	40	20	3/4" (26,44mm)	82 (88)	74	4x M8	4,49 €*
PB0300.040.032	40mm x 1"	87	40	21,5	1" (33,25mm)	87 (93)	74	4x M8	7,31 €*
PB0300.050.020	50mm x 1/2"	101	50	15	1/2" (20,96mm)	94 (96mm)	77	4x M8	4,49 €*
PB0300.050.025	50mm x 3/4"	101	50	20	3/4" (20,44mm)	95 (---)	78	4x M8	5,00 €*
PB0300.050.032	50mm x 1"	101,5	50	20	1" (33,25mm)	100 (103)	77	4x M8	7,77 €*
PB0300.063.020	63mm x 1/2"	117	63	15	1/2" (20,96mm)	107 (---)	87	4x M8	5,17 €*
PB0300.063.025	63mm x 3/4"	112	63	20	3/4" (26,44mm)	108 (---)	87	4x M8	5,67 €*
PB0300.063.032	63mm x 1"	117	63	26	1" (33,25mm)	112 (---)	87	4x M8	7,94 €*

* alle Preise netto exkl. gesetzliche MwSt.

HT CONNECT GmbH & Co. KG - Norisstraße 4 - 91257 Pegnitz - Tel.: 09241/9109100 - Mail: info@ht-connect.de